

Toshiba Air Conditioning - RAS Data Sheet

RAS-2M10U2AVG-E Multi-Split Outdoor Unit

Features

- Wide range of indoor units available for use with refrigerant R32
- Wide operating range (cooling mode -10°C to +46°C)
- Vertical pipe lengths up to 10 metres
- Compact size
- Superior reliability due to Toshiba's unique inverter compressor



Technical Data

Model reference		RAS-2M10U2AVG-E
Nominal cooling	kW	3.3
Nominal heating	kW	4.0
Sound power (high)	dB(A)	59
Sound pressure (high)	dB(A)	46
Dimensions (H x W x D)	mm	630 x 800 x 300
Unit weight	kg	38
Power supply	V-ph-Hz	220/240-1-50
Interconnecting cable per indoor unit		3-core + earth
Suggested fuse size	A	10
Maximum operating current (cooling)	A	4.17
Operating range, cooling	°C	-10-46
Operating range, heating	°C	-20-24
Minimum number of indoor units		2
Maximum number of indoor units		2
Pipe sizes, unit A (liquid-suction)	inch	1/4-3/8
Pipe sizes, unit B (liquid-suction)	inch	1/4-3/8
Pipe lengths per unit (min./max.)	m	2-15
Maximum pipe length	m	20
Maximum height difference	m	10
Pre-charge pipe length	m	20
Additional refrigerant - factory charge	g/m - kg	N/A - 0.85

Dimensional Drawings

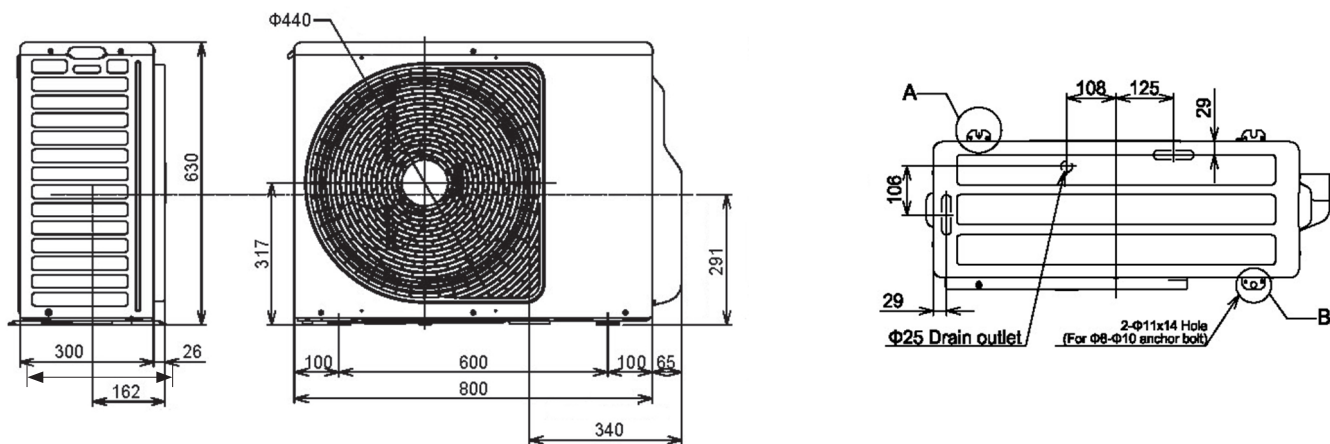

Cool Designs Ltd

Raising the Standards in Air Conditioning Distribution

www.cdlweb.info

